

## ***Operating Instructions***

### ***Glue Gun TR 500 / 501 / 502 / 505 / 101***

TR 500 / 501 / 502



TR 505



TR 101

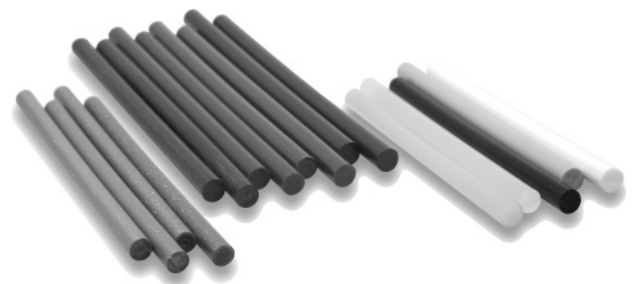

---

# Table of Contents

|                              |   |
|------------------------------|---|
| General Safety Instructions  | 3 |
| Product Description          | 3 |
| Start-up and Control         | 3 |
| During Operation             | 4 |
| Cleaning and Maintenance     | 4 |
| Replacement of Nozzles       | 4 |
| Tips for Glueing             | 5 |
| Trouble-Shooting             | 5 |
| Additional Information       | 6 |
| Additional Nozzles           | 6 |
| CE Declaration of Conformity | 7 |
| Technical Data               | 8 |

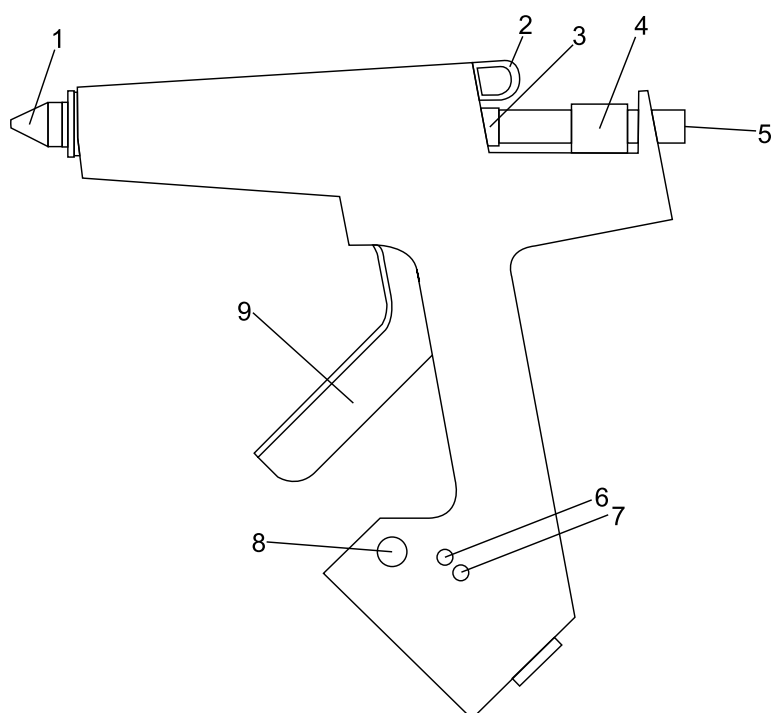

## No. Description

- 1 Nozzle
- 2 Bail
- 3 Glue Stick Inlet
- 4 Glue Stick Feeder
- 5 Glue Stick 11,3 mm
- 6 LED Indication Heater (red)
- 7 LED Indication Power (green)
- 8 Temperature Regulation (TR 500 only)
- 9 Trigger

## General Safety Instructions



The working temperature of the glue must not be exceeded. You may find it in the technical datasheet of the respective glue. Overheating may lead to decomposition which may affect the health of the user as well as the operability of the applicator.



Once the applicator has warmed up, nozzle and lid are very hot.

Never start working before fitting a nozzle first.

Only replace nozzle when applicator is warmed up. (60° - 80° C device temperature).

Unplug the connecting cable, before replacing a nozzle. Warning: risk of burns! When a nozzle is replaced, liquid glue might leak out.

Never bring the hot nozzle into contact with the cable.

Never direct the glue jet towards people.

Always deposit the glue applicator on the wire stand or the respective plate destined for this purpose.

Do not lay the applicator on its side.

Always keep the hot glue gun out of reach of children.

When your skin got into contact with hot glue, cool it with cold water immediately. Do not try to remove the hotmelt from the skin first. If necessary, consult a doctor.

When hot adhesive got into your eyes, immediately cool them under running water for about 15 minutes and consult your doctor at once.

## Product Description

Dear customer,

The glue applicator you purchased will help you to glue parts together more easily and more rapidly. To ensure an optimum usage of the glue applicator we recommend that you read these instructions thoroughly before using the applicator for the first time. The glue guns TR 500 / 501 / 502 / 505 / 101 let you process hot-melt sticks of 90-300 mm length and 11,3 mm approximate diameter.

## Start-up and Control

Checklist:

- Plug the connecting cable into socket
- TR 500 / TR 501: Are the LEDs lit?
  - ▶ Green: Power / Red: Heater
- Stick to the heat up time of 2 - 7 minutes.
- Keep the nozzle free of foreign substances.

Minor leaking during heat-up phase is due to hot-melt expanding in the nozzle/heating chamber.

## Loading Hot-Melt

When using the glue gun for the first time, insert a hot-melt stick. You can process hot-melt sticks of 90 – 300 mm length and 11,3 ± 0,2mm diameter.

When the stick is used up to the point that the feed does not push it forward anymore, insert another hot-melt stick.

## TR 500: Adjust Temperature

- approx. 110 °C
- approx. 130 °C
- approx. 155 °C
- approx. 190 °C

Measured at the nozzle tip, meaning the working temperature at ●●●● is approx. 200 °C

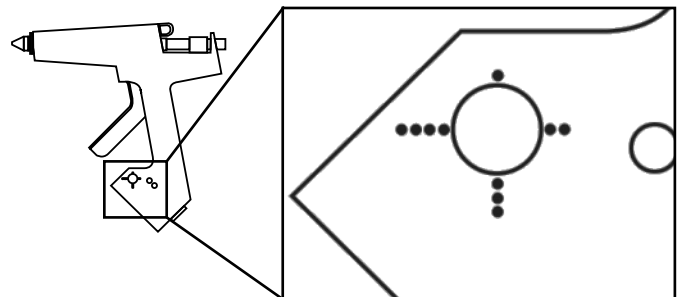

---

## Applying Hot-Melt

The quantity to be applied is determined by pulling the trigger: the more you pull the more glue is dispensed. When the feeding of glue sticks is stopped, the ball valve integrated in the nozzle will close, thus preventing liquid glue from leaking out.

When the glue is used up so that it stops flowing out when the hand trigger is pressed, insert a new glue stick.

Only use hot-melt that is suited to use with your applicator. Please mind the respective working temperature of the hot-melt (TR 500: approx. 115 - 200°C; TR 501: approx. 195°C; TR 502, TR 505, 101: approx. 190 - 200°C)\*. This temperature is indicated in the technical datasheet of the hot melt. This temperature must not be exceeded, otherwise the glue may coke in the glue applicator. Hot-melts on a polyamide basis are particularly sensitive. Low-Melt hot-melts can only be applied with the model TR 500 and the corresponding temperature setting.

\* PTC-devices are subject to temperature variation

## During Operation

Having worked with some glue sticks, the glue gun needs some time to reheat.

Never pull the trigger with force! If you feel resistance when pulling the trigger, wait one or two minutes, so the glue gun can melt the glue properly.

In case the nozzle is clogged or the hot-melt is not fully melted, glue may flow out the glue stick inlet. Remove it while the glue gun is lukewarm (approx. 40 °C). Do not use any sharp or pointed tools.

The cable of the glue guns TR 500, 501 and 502 can be removed for a short period of time. This enables the user to apply glue to places that are difficult to access.

If the glue applicator isn't used for 30 minutes or more, unplug it to preserve the hot-melt.

Always deposit the glue gun on the wire stand or the respective plate destined for this purpose.

After unplugging the device, unprocessed hot-melt glue will stay in the glue gun. The glue remaining in the gun will remelt and can be used during next use.

## Cleaning and Maintenance

Never fill soiled glue into the melting tank. If you observe all advices given in the operating manual, the glue applicator does normally not need cleaning. The glue contained in the applicator will remelt and can be used for gluing again.

If the applicator is used very often, we recommend having it maintained regularly. For this, fix a date with our service department.

## Replacement of Nozzles

For your own safety: wear protective gloves and safety goggles when you replace nozzles.

Always unplug the glue gun before replacing a nozzle!

Use heat-resistant gloves or a thick cloth for changing a nozzle. Do not use tools like a nipper!

Only replace nozzles when the glue applicator is warm (instrument temperature 60 – 80 °C ) and empty. Replacing a nozzle when the applicator is cold may damage the equipment. Replacing the nozzle when the applicator is too hot, causes liquid glue to flow out.

Warning: Risk of burning!

The melting range as well as the melting point of the used glue may be taken from the technical datasheet of the respective glue.

An overview of the current Reka nozzle range can be found on page 6 of the operational manual.

## Tips for Glueing

To achieve better bonding results

- ▶ the about to be bonded materials should be clean, free of fats and oils and dry.
- ▶ cold material like metal, stone and ceramic should be pre-heated.
- ▶ hot hot-melt should at first be applied to the surface which according to your experience builds up less adhesive strength to the hot-melt glue.

Use a silicone mat or silicone paper as work underlay.

A hot-melt destined for the respective bond can improve the result.

Reka has a variety of different 11,3mm hot-melt glue sticks and will assist you making your choice (Tel: +49 721 970 780).

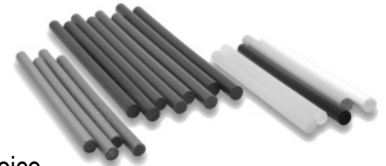







## Trouble-Shooting

List of possible fault indications and assistance in trouble-shooting.

In case of damage, send the glue applicator alongside with your mailing address to Reka, indicating type of your applicator. Warranty expires when repairs are made by yourself.

| Fault  | Possible cause  | Measures to be taken   |
|--|---|--|
| No or too little glue output though the heat-up time has been kept | <ul style="list-style-type: none"> <li>▶ Clogged nozzle.</li> <li>▶ Temperature too low.</li> </ul>   | <ul style="list-style-type: none"> <li>▶ Unscrew nozzle to clean or exchange it</li> <li>▶ Extend heat-up time to 15 minutes</li> <li>▶ TR 500: Check temperature setting</li> </ul>   |
| Leaking nozzle   | <ul style="list-style-type: none"> <li>▶ Diameter of glue stick is too big.</li> <li>▶ Nozzle is clogged.</li> <li>▶ Spring pressure of nozzle is too low.</li> </ul>                         | <ul style="list-style-type: none"> <li>▶ Check diameter of the used glue stick (recommended size: 11,3mm).</li> <li>▶ Unscrew the nozzle and clean it carefully or replace it. Unscrew the nozzle only when the device is warm (60 - 80 °C) ; Wear heat resistant gloves (Risk of burning).</li> <li>▶ Exchange the worn out nozzle</li> </ul> |
| Hot-melt glue is too fluid or too solid                            | Temperature of glue gun is too high or too low  | Check and adjust temperature   |
| Glue gun does not heat up  | <ul style="list-style-type: none"> <li>▶ The cable isn't properly connected to socket at the glue gun</li> <li>▶ The glue gun is not plugged in</li> <li>▶ Electronics malfunction</li> </ul> | <ul style="list-style-type: none"> <li>▶ Check if the cable is plugged in the glue gun and power outlet correctly.</li> <li>▶ Send in the glue gun.</li> </ul>   |
| Force has to be used to pull the trigger                           | Melted glue is sticking to the glue stick inlet after the glue gun has been turned on, but not used for a while   | Twist the glue stick for a quarter turn, so the melted glue comes off the inlet.   |

## Additional Nozzles

| Product No.  | Ø in mm | Thread | Description  | Suitable for                         |
|--|---------|--------|--|--------------------------------------|
| 1143    | 1,9     | M10    | Standard-Nozzle M10                                      | TR 101                               |
| 2096    | 1,9     | M14    | Standard-Nozzle M14                                      | TR 500<br>TR 501<br>TR 502<br>TR 505 |
| 3504    | 1,5     | M10    | Injection Needle Nozzle M10                              | TR 101                               |
| 3648   | 1,5     | M14    | Injection Needle Nozzle M14                              | TR 500<br>TR 501<br>TR 502<br>TR 505 |
| 3501  |         |        | Nozzle Set M10 / M6<br>Contains nozzles 3508, 3502, 3503 | TR 101                               |
| 3636  |         |        | Nozzle Set M14 / M6<br>Contains nozzles 3634, 3502, 3503 | TR 500<br>TR 501<br>TR 502<br>TR 505 |

## Additional Information

Please contact us by

Phone +49 721 970 780  
Telefax +49 721 705 069

E-Mail: [sale@reka-klebeteknik.de](mailto:sale@reka-klebeteknik.de)

Our mailing address is:

Reka Klebeteknik GmbH & Co. KG  
Siemensstr. 6  
D-76344 Eggenstein

Internet: <http://www.reka-klebeteknik.de>

## Environmental Protection

Never throw electric tools in the domestic waste. According to the European directive 2002/96/EC for used electric and electronic devices and according to national regulations, used electric tools must be collected separately and treated in an environmentally compatible way for re-use.

Reka packing material can be recycled completely.

Please take instructions for the disposal of hot-melt glues and hot-melt cartridges from the respective safety datasheet.

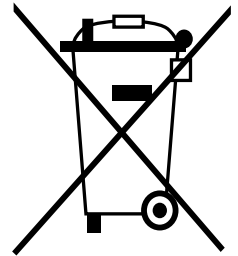

## EU Declaration of Conformity

Product: Hot-Melt Glue Applicator

Type: TR 500 / 501 / 502 / 505 / 101

This is to certify that the applicators above in the design marketed by us are in conformity with the following EC directives:

Until 15-01-2007: 73/23/EEC, from 16-01-2007: 2006/95 EC  
until 19-07-2009: 91/368 EEC, from 20-09-2009: 2004/108 EC  
until 28-12-2009: 89/336 EEC, from 29-12-2009: 2006/42 EC  
2002/95/EC

The following standards have been applied:

IEC CISPR14  
IEC 60335  
IEC 60204  
IEC 61000

This declaration of conformity shall get invalid,

- if the product is modified, extended, or otherwise changed,
- and/or other components than accessories of Reka Klebetechnik are fitted,
- and if the product is not connected or used as intended

without expressed approval of Reka Klebetechnik GmbH & Co. KG

Eggenstein-Leopoldshafen, May 23rd, 2011

Christa Armbruster

Management Purchasing and Production

## Technical Data

|                                   | <b>TR 500</b> | <b>TR 501</b> | <b>TR 502</b> | <b>TR 505</b> | <b>TR 101</b> |
|-----------------------------------|---------------|---------------|---------------|---------------|---------------|
| <i>Power supply</i>               | 230 V         | 230 V         | 230 V         | 230 V         | 230 V         |
| <i>Power consumption</i>          | 125 W         | 125 W         | 35W*(500W)    | 35 W* (500W)  | 35 W* (500W)  |
| <i>Temperature control</i>        | electronic    | electronic    | PTC           | PTC           | PTC           |
| <i>Operating temperature</i>      | 100 - 205°C** | ca. 195 °C    | ca. 195°C     | ca. 195 °C    | ca. 195 °C    |
| <i>Max. application.</i>          | 1.650 g***    | 1.650 g***    | 950 g***      | 950 g***      | 700 g***      |
| <i>LED indication for power</i>   | yes           | yes           | ---           | ---           | ---           |
| <i>LED indication for heating</i> | yes           | yes           | ---           | ---           | ---           |
| <i>Gluestick-Ø</i>                | 11,3 ±0,2 mm  | 11,3 ±0,2 mm  | 11,3 ±0,2 mm  | 11,3 ±0,2 mm  | 11,3 ±0,2 mm  |
| <i>Weight</i>                     | 400 g         | 400 g         | 400 g         | 330 g         | 380 G         |
| <i>Magnetic deposit</i>           | yes           | yes           | yes           | no            | no            |
| <i>Removeable cable</i>           | yes           | yes           | yes           | no            | no            |
| <i>Stand for storing</i>          | yes           | yes           | yes           | no            | no            |
| <i>Wirestand</i>                  | no            | no            | no            | yes           | yes           |

\* When gun is cold, power consumption is very high (temporarily up to 500 W)

\*\* Temperature continuously adjustable from 100-205°C; hence, the gun also can work with LowTemperature glue sticks.

\*\*\* Measured on the throughput during the first minute.

Reka Klebetechnik GmbH & Co. KG  
 Siemensstr. 6  
 D-76344 Eggenstein  
 Phone: +49 721 970 780  
 Telefax: +49 721 705 069  
 E-Mail: [sale@reka-klebetechnik.de](mailto:sale@reka-klebetechnik.de)  
 Internet: [www.reka-klebetechnik.de](http://www.reka-klebetechnik.de)