

## MS 80 – Zusatzdüsen / Additional Nozzles



**MS 80**  
# 5551 (230 V)  
# 5560 (120 V)

Düse Nr. 2  
Nozzle No.2  
Ø 1,75 mm # 3911



Düse Nr. 3  
Nozzle No. 3  
Ø 2,5 mm # 3905



Spitzdüse  
Pointed Nozzle  
Ø 1,75 mm # 3901



Schlitzdüse 10x0,5  
Pointed Nozzle 10x0,5  
Ø 10 x 0,5 mm # 2642



Schlitzdüse 18x0,5  
Pointed Nozzle 18x0,5  
Ø 18 x 0,5 mm # 3681



## MS 80 – Zusatzdüsen / Additional Nozzles



**MS 80**  
 # 5551 (230 V)  
 # 5560 (120 V)

Adapter  
 Nozzle Holder  
 # 3961

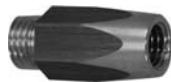

Düse  
 Nozzle  
 Ø 1,9 mm # 1143



Injektionsdüse  
 Injection Needle  
 Ø 1,5 mm # 3504



Verschlussdüse  
 Threaded Nozzle  
 Ø 1 mm # 3208



Verschlussdüse  
 Threaded Nozzle  
 Ø 1,5 mm # 3240



Verschlussdüse  
 Threaded Nozzle  
 Ø 1,9 mm # 3205



Düsenkappe  
 Threaded Cap  
 # 3135















Verschlussdüse  
 Threaded Nozzle  
 Ø 2,5 mm # 3206



Verschlussdüse  
 Threaded Nozzle  
 Ø 3 mm # 3207

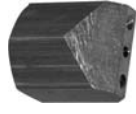

## MS 80 – Zusatzdüsen / Additional Nozzles

 <p><b>MS 80</b>                  # 5551 (230 V)                  # 5560 (120 V)</p>	<p>Adapter                  Nozzle Holder                  # 3961</p> 	<p>Grunddüse                  Basic Nozzle                  # 3508</p> 	<p>Düseneinsatz / Nozzle Insert                  Ø 4 mm # 3502</p> 
			<p>Düseneinsatz                  Nozzle Insert Flat                  Ø 5,5 x 1,5 mm # 3531</p> 
			<p>Kehlhahtdüse / Nozzle Insert                  Diagonal                  Ø 4 mm # 3503</p> 
			<p>Injektionsnadel / Injection Needle                  Ø 1,5 mm # 3509</p> 
			<p>2-Lochdüse / 2-Hole Nozzle                  Ø 1,5 mm # 3670</p> 
			<p>3-Lochdüse / 3-Hole Nozzle                  Ø 1,5 mm # 3671</p> 
	<p>Adapter                  Nozzle Holder                  # 3961</p> 	<p>Adapter                  Adapter                  # 3688</p> 	<p>5-Lochdüse / 5-Hole Nozzle                  Ø 1 mm # 3679</p> 
			<p>Verlängerungsdüse                  Extension Nozzle Diag.                  Ø 3 mm # 3676</p> 
			<p>Nadeldüse / Needle Jet                  Ø 1,2 mm # 3677</p> 